



MARINA LUCE 2015

Il Paralume Marina

Made in Italy

Made in Italy



1

HANDMADE, IT'S A SURPLUS

The added value of MARINA LUCE will always be the quality of our products. All the chandeliers come out the factory as unique pieces handmade one by one by our incredibly talented seamstresses. They are led by the one and only MARINA, the founder of the company and master of beauty, that hands down all the secrets to the new generation.



2

3

THE STRENGTH AND THE UNIQUENESS OF MURANO'S
GLASS REVIVE IN THIS CONTEMPORARY INTERPRETATION
OF CA' REZZONICO: THE MIRRORRED ELEMENTS GIVE
POETIC ELEGANCE TO ANY INTERIOR.

Art. 1932/CH24
H 92 cm ø 144 cm
24 x E14 x 40W



Il Parolome Marina



Art.1954/G
H 92 cm Pø 29 cm
1 x E27 x 60W

Art.1954/P
H 67 cm Pø 23 cm
1 x E27 x 40W



Art.1948/LU
H 98 cm P oval 46x25 cm
1 x E27 x 60W
Nappa N.10 Oro

Art.1932/A1
H 52 cm L 10 cm
Sp 18 cm
1 x E14 x 60W

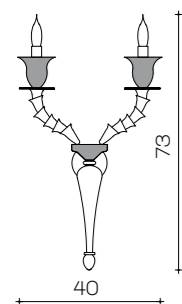

Art.1932/A2
H 73 cm L 40 cm Sp 24 cm
2 x E14 x 60W

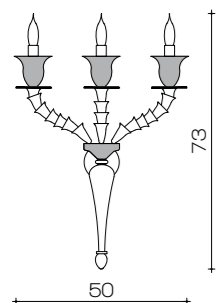

Art.1932/A3
H 73 cm L 50 cm Sp 24 cm
3 x E14 x 60W



Art.1935/FL
H 187 cm Pø 58 cm
2 x E27 x 60W

Art.1935/CH8
H 82 cm ø 114 cm Pø 24 cm
8 x E14 x 40W





Art.1932/CH8
H 82 cm ø 96 cm
8 x E14 x 40W



Art.1947/NL
H 98 cm Pø 38 cm
1 x E27 x 60W
Nappa N.10 Argento



Art.1970/CH8/NL
H 80 cm ø 113 cm
8 x E14 x 40W

design:
Arch. Federica Vicentini
"International Design
Registration N°: DM/079817"



Art.1969/CH8/NL
H 80 cm ø 107 cm
8 x E14 x 40W





12



13

Art.1965/CH15
H 80 cm ø 110 cm
15 x G9 X 40W

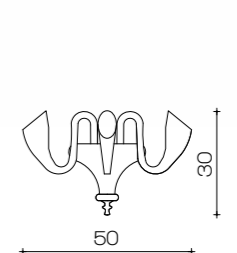

Art.1965/A3
H 30 cm ø 50 cm
3 x G9 X 40W

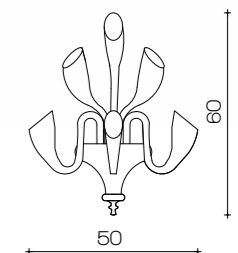

Art.1965/A6
H 60 cm ø 50 cm
6 x G9 X 40W

Art.1930/CH12
 H 95 cm ø 131 cm Pø 18 cm
 12 x E14 x 40W

MURANO'S GLASS FLAMES ANIMATE THIS COLLECTION.
 PASSION WITH HANDCRAFTED DEVOTION AND DESIGN ARE COMBINED
 INTO THIS LIFESTYLE ECLECTIC AND HARMONIC AT THE SAME TIME

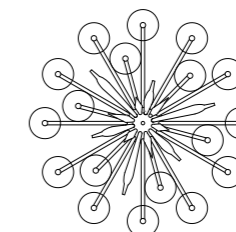
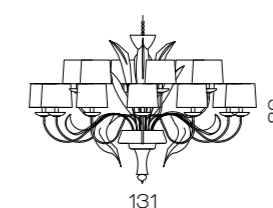
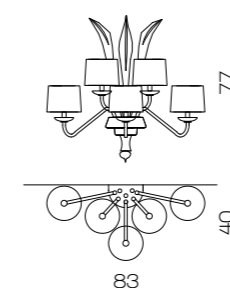
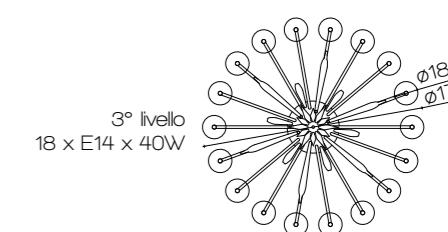
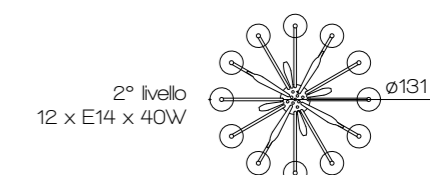
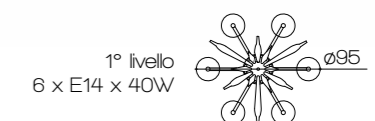
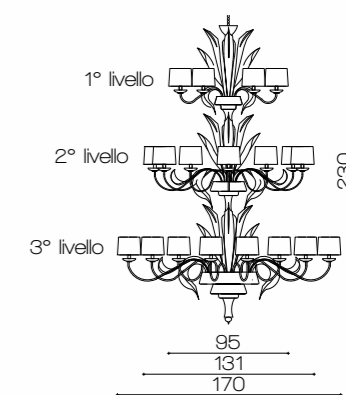

Art.1930/A5
 H 77 cm L 83 cm Pø 18 cm Sp 40 cm
 5 x E14 x 25W

Art.1930/CH18
 H 86 cm ø 131 cm Pø 18 cm
 18 x E14 x 40W

Art.1930/CH36
 H 230 cm ø 170 cm Pø 18 cm
 36 x E14 x 40W



Art.1931/CH12
H 95 cm ø 117 cm
12 x E14 x 40W



Art.1931/G/HONEY
H 97 cm Pø 37 cm
1 x E27 x 60W



Art.1931/G/CAFFÉ
H 97 cm Pø 37 cm
1 x E27 x 60W



Art.1931/A2
H 64 cm L 40 cm
Sp 20 cm
2 x E14 x 40W



Art.1931/CH8
H 77 cm ø 89 cm
8 x E14 x 40W





Art.1931/G/HONEY
H 97 cm Pø 37 cm
1 x E27 x 60W



Art.1931/G/CAFFÉ
H 97 cm Pø 37 cm
1 x E27 x 60W



Art.1931/G/RED
H 97 cm Pø 37 cm
1 x E27 x 60W



Art.1931/G/FUMÉ
H 97 cm Pø 37 cm
1 x E27 x 60W



Art. 1919/CH54
H 160 cm L 190x91 cm Pø 12 cm
54 x E14 x 40W + 7 spot 50W
with Asfour crystal



THREE LEVELS OF SOFTENED NICKEL RECTANGLES ARE DANCING IN A VERY EXCLUSIVE AND ELEGANT COMPOSITION. THE SPARKLING CANDLES ARE MADE WITH ITALIAN CRYSTAL AND THE PARALUMI WITH GREY ORGANZA AND PVC ARE DECORATED WITH SHINY CHAINS IN BLACK NICKEL. A CONTEMPORARY AND EXCLUSIVE SIGNATURE. MADE BY IL PARALUME MARINA

Art. 1918/CH54
H 100 cm L 190x91 cm Pø 12 cm
54 x E14 x 40W
+ 7 dirotte 50W





Art.1918/CH32
H 75 cm L 160x65 cm Pø 12 cm
32 x E14 x 40W + 7 diroiche 50W



Art. 1950/BI
H 74 cm Pø 40 cm
1 x E27 x 60W
RAL9016



Art. 1945/BI
H 74 cm Pø 48 cm
1 x E27 x 60W
RAL9016

Art. 1945/NN
H 74 cm Pø 48 cm
1 x E27 x 60W



Art.1892
H 126 cm Pø 45 cm
1 x E27 x 60W

Art.1913/CH8/NN
H 80 cm ø 92 cm Pø 15 cm
8 x E14x 40W + 3 diicroiche 60W



SMALL LAMPS WITH ITALIAN CRYSTAL COMPLETELY
HAND-GRINDED AND JOINED WITH A BLACK NICKEL FINISHED
RING CREATE A GLAMOUR AND CLEAN DESIGN



- Art.1913/P/VE
H 20 cm Pø 15 cm
1 x E14 x 40W
- Art.1913/P/AZZ
H 20 cm Pø 15 cm
1 x E14 x 40W
- Art.1913/P/TR
H 20 cm Pø 15 cm
1 x E14 x 40W
- Art.1913/P/RS
H 20 cm Pø 15 cm
1 x E14 x 40W
- Art.1913/P/M
H 20 cm Pø 15 cm
1 x E14 x 40W



Art.1913/A1/NL
H 20 cm Pø 15 cm
1 x E14 x 40 W



Art. 1916/P
H 20 cm Pø 15 cm
1 x E14 x 40W



Art. 1915/P
H 20 cm Pø 15 cm
1 x E14 x 40W

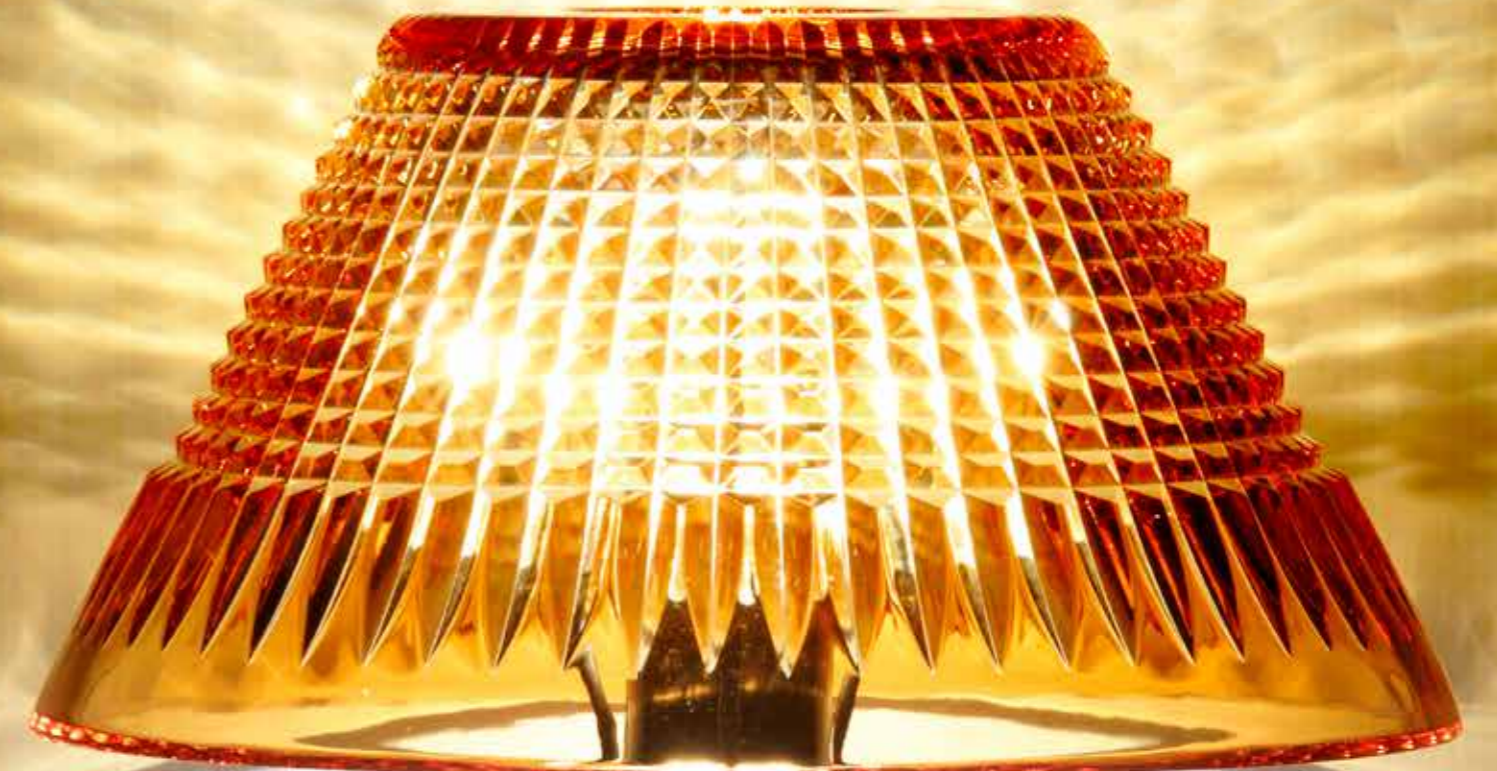

Art. 1913/G/AM
H 30 cm Pø 15 cm
1 x E27 x 60W

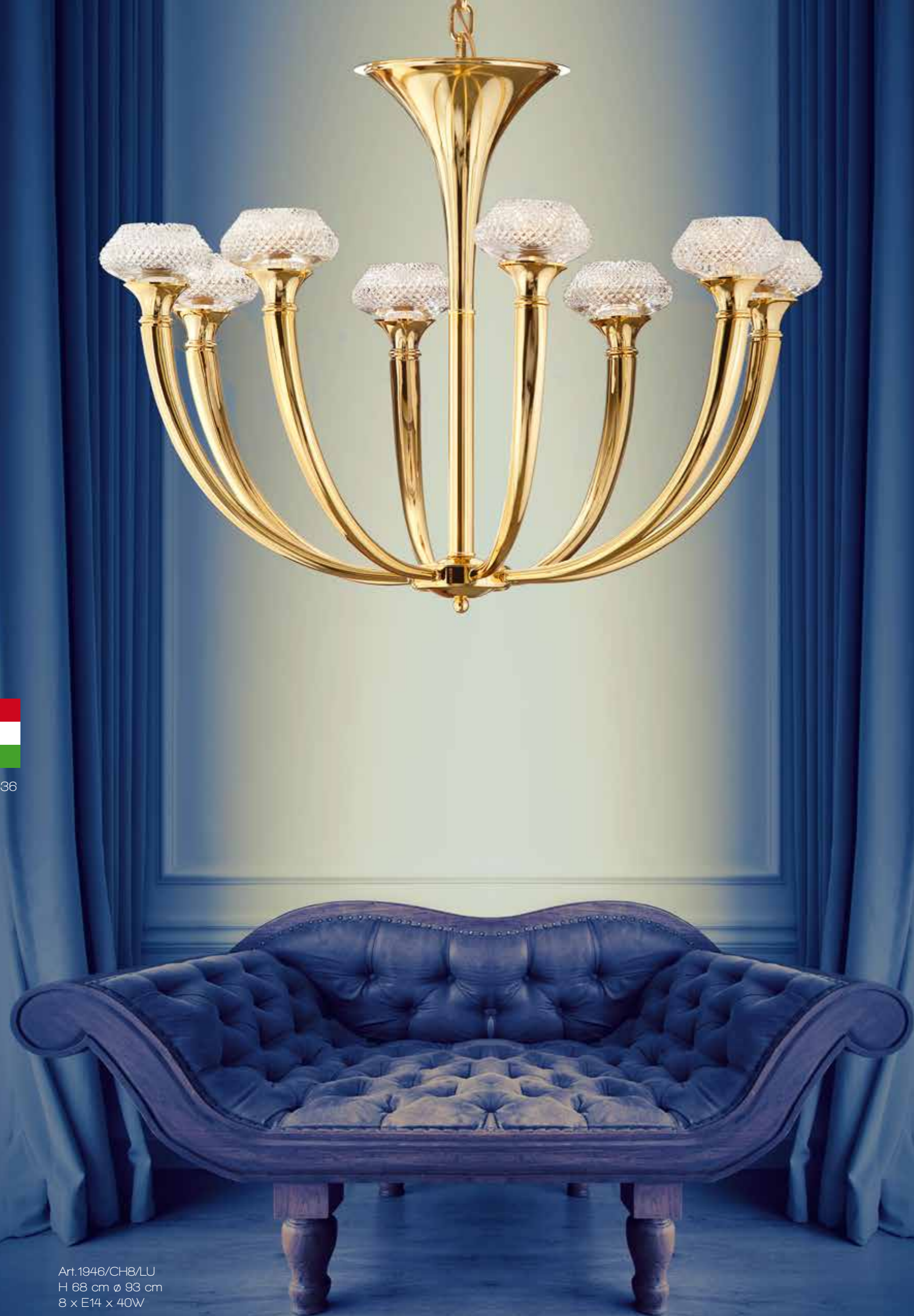

Art.1946/CH8/LU
H 68 cm ø 93 cm
8 x E14 x 40W

Art.1946/CH8/NL
H 68 cm ø 93 cm
8 x E14 x 40W

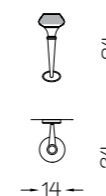

Art.1946/A1/NL
H 34 cm L 14 cm
Sp 24 cm
1 x E14 x 40W

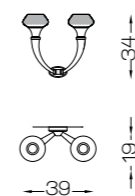

Art.1946/A2/NL
H 34 cm L 39 cm
Sp 19 cm
2 x E14 x 40W

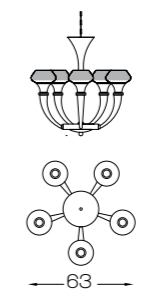

Art.1946/CH5/NL
H 55 cm ø 63 cm
5 x E14 x 40W

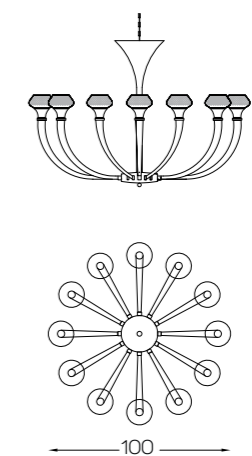

Art.1946/CH12/NL
H 80 cm ø 100 cm
12 x E14 x 40W

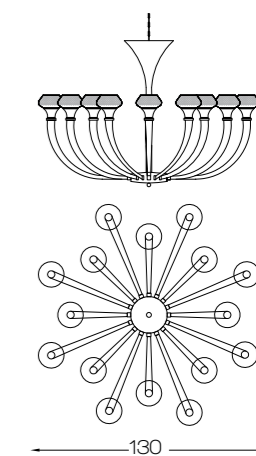

Art.1946/CH16/NL
H 80 cm ø 130 cm
16 x E14 x 40W



Art.1946/NL/AZ
H 104 cm Pø 34 cm
1 x E27 x 60W
1 x G9 x 25W

Design: Arch. Federica Vicentini



Art.1946/NL/AM
H 104 cm Pø 34 cm
1 x E27 x 60W
1 x G9 x 25W

Art.1946/NL/AZ
H 104 cm Pø 34 cm
1 x E27 x 60W
1 x G9 x 25W

Art.1946/NL/TR
H 104 cm Pø 34 cm
1 x E27 x 60W
1 x G9 x 25W

Art.1946/NL/VE
H 104 cm Pø 34 cm
1 x E27 x 60W
1 x G9 x 25W





Art.1952/LU/AM
H 77 cm Pø 30 cm
1 x E27 x 60W

Art.1952/NL/GR
H 77 cm Pø 30 cm
1 x E27 x 60W

Art.1952/NL/BI
H 77 cm Pø 30 cm
1 x E27 x 60W



Art.1943/NN/AM
H 66 cm Pø 35 cm
1 x E27 x 60W

Art.1944/NN/GR
H 66 cm Pø 35 cm
1 x E27 x 60W

Art.1912/A3
H 50 cm Sp 44 cm
L 67 cm Pø 18 cm
3 x E14 x 40W

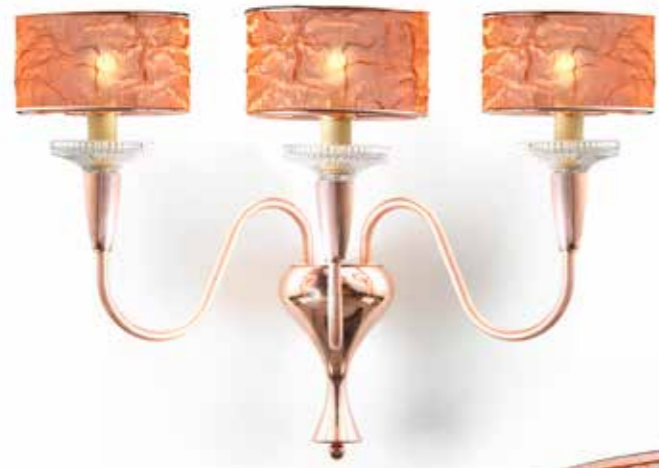

Art.1912/P
H 46 cm Pø 25 cm
1 x E27 x 60W

Art.1912/G
H 82 cm Pø 40 cm
1 x E27 x 60W



SET OF LIGHTING OBJECTS BY EXCLUSIVE DESIGN OBTAINED FROM DIMPLED TUBE, LAMP SHADES IN FABRIC WITH COPPER. ON TRANSPARENT PVC BASE AND SHINY METAL PARTS MAKE THIS COMBINATION WELL-BALANCED

Art.1912/CH12
H 102 cm ø 140 cm
Pø 18 cm
12 x E14 x 40W





Art.1912/CH8/ORO24K
H 75 cm ø 111 cm
Pø 18 cm
8 x E14 x 40W



Art.1912/CH5/NL
H 54 cm ø 74 cm
Pø 18 cm
5 x E14 x 40W





Art.1910/CH8/ORO24K
 H 106 cm ø 97 cm
 8 x E14 x 60W
 3 Diariche 60W

Art.1910/A1/ORO24K
 H 43 cm L 25 cm Sp 15 cm
 1 x E14 x 60W
 + Led SMD bianco freddo Lumen 60
 su Flex Strip 1,07W



COLLECTION OF LIGHTING OBJECTS WITH MICRO
 CASTING ANIMALS, ENAMELED BRASS AND BOBCCHE
 IN CLEAR ITALIAN HAND-CUT CRYSTAL.



Art.1910/G/ORO24K
H 27 cm L 24 cm Sp 4,5 cm
Led SMD bianco freddo Lumen 120 su
Flex Strip 2,14W



Art.1911/A/ORO24K
H 4,5 cm L 25 cm Sp 15 cm
Led SMD bianco freddo Lumen
60 su Flex Strip 1,07W

Art.1910/P/ORO24K
H 21 cm L 20 cm Sp 4,5 cm
Led SMD bianco freddo Lumen 70
su Flex Strip 1,26W



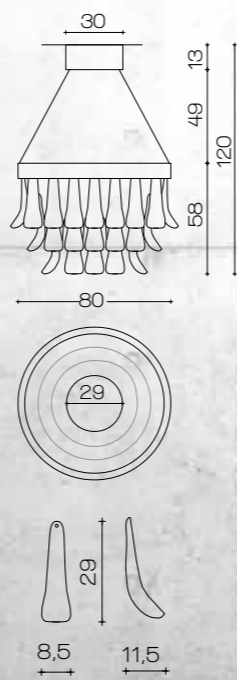

Art. 1939 Chandelier
 H 58 cm ø 80 cm + Ceiling plate
 H 13 cm ø 30 cm with 3 spot Led
 (5W 450 LUMEN)
 H tot. 120 cm + Strip Led
 Colour light 2700 K° Lumen 8550

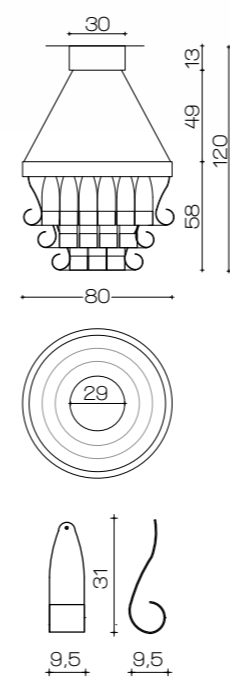

Art. 1937 Chandelier
 H 58 cm ø 80 cm + Ceiling plate
 H 13 cm ø 30 cm with 3 spot Led
 (5W 450 LUMEN)
 H tot. 120 cm + Strip Led
 Colour light 2700 K° Lumen 8550

ILLUMINATING METAL RINGS WITH POLISHED GOLD, PRICELESS AND FANTASTIC GLASS' JEWELLERY FROM THE ANCIENT ITALIAN TRADITION, REVISITED IN A CONTEMPORARY DESIGN. A FANTASY AND STRICTNESS MIX

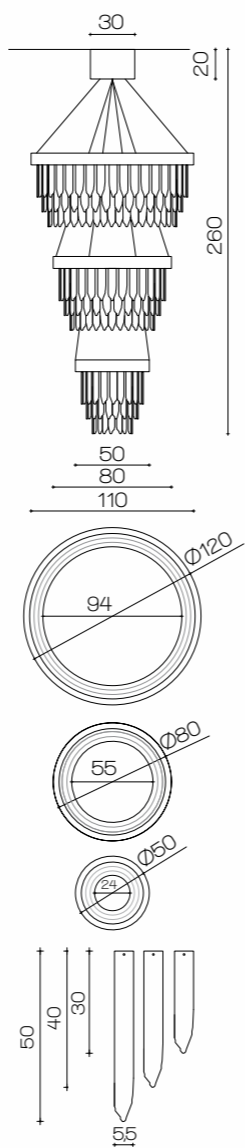

Art.1961/LU
 H 260 cm ø 120 cm
 + Ceiling plate H 20 cm ø 30 cm with 3
 spot Led (5W 450 LUMEN) + Strip Led
 Colour light 2700°K Lumen 16530

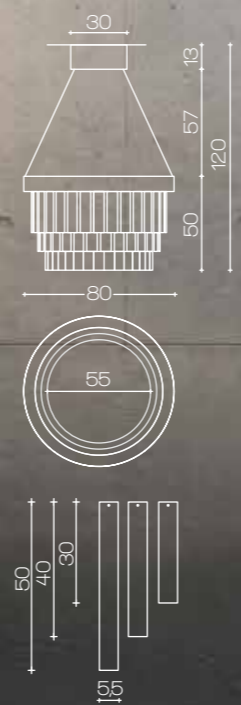

Art.1938 Chandelier
 H 52 cm ø 80 cm + Ceiling plate
 H 13 cm ø 30 cm with 3 spot Led
 (5W 450 LUMEN)
 H tot. 120 cm + Strip Led
 Colour light 2700 K° Lumen 8550





54

Art.1966/NL
 H 130 cm ø 90 cm
 (only chandelier H 55 cm)
 12 x E14 x 40W
 + 3 GU10 led x 4W



55

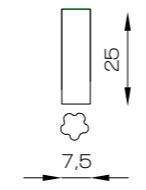

Art.1960
 H 43 cm ø 80 cm + Ceiling plate
 H 13 cm ø 30 cm with 3 spot Led
 (5W 450 LUMEN) H tot. 120 cm
 Colour light 2700 K° Lumen 8550

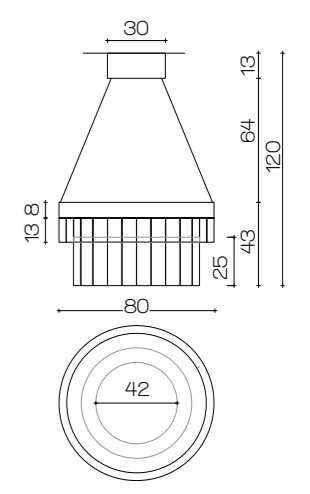

Il Paralume Marina

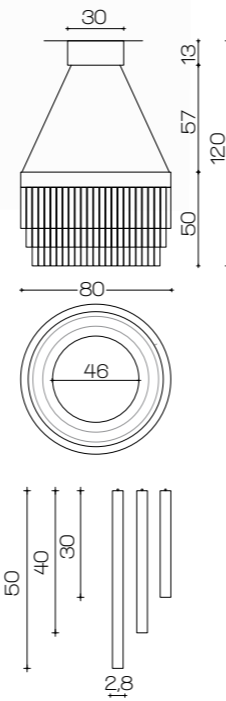

Art.1971
 H 50 cm ø 80 cm + Ceiling plate
 H 13 cm ø 30 cm with 3 spot Led
 (5W 450 LUMEN) H tot. 120 cm
 Luce colore 2700 K° Lumen 8550

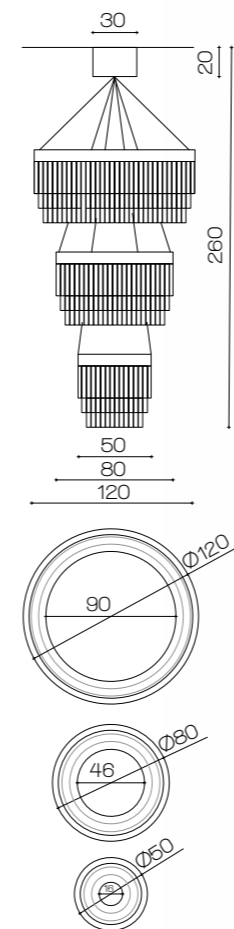

Art.1972
 H 260 cm ø 120 cm
 + Ceiling plate H 20 cm ø 30 cm with 3
 spot Led (5W 450 LUMEN) + Strip Led
 Colour light 2700°K Lumen 16530

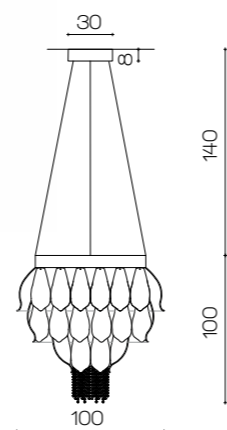

Art.1984/P
 H 100 cm ø 100 cm
 + H ring spot ø 30 cm
 H 8 cm Steel cable 140 cm
 9 x E27 x 60W + 3 spot 50 watt

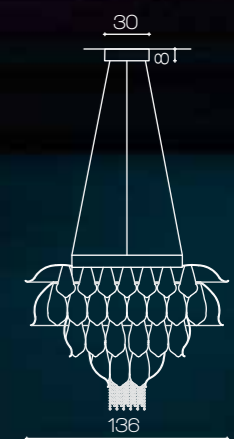

Art.1984/G Chandelier
 with Glass leaf perl color
 H 105 cm ø 136 cm
 + H ring spot ø 30 cm
 H 8 cm Steel cable 140 cm
 12 x E27 x 60W + 3 spot x 50W



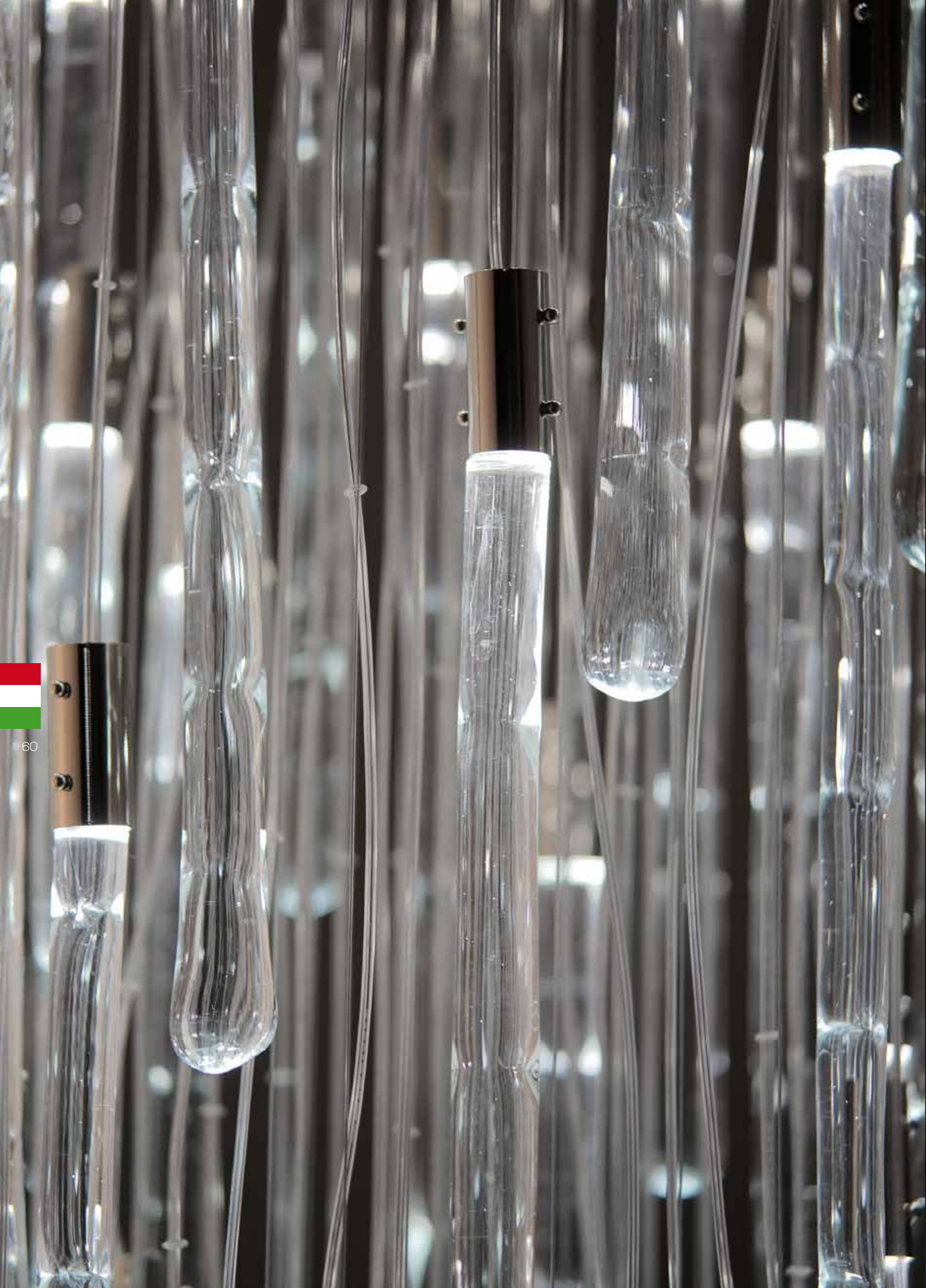

Art.1933
MURANO GLASS BAMBU'
H 285 cm ø 56 cm
15 x E14 x 40W

Art.1933 LED
MURANO GLASS BAMBU'
H 285 cm ø 56 cm
57 LED 450W

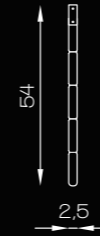

WATERFALL OF LIGHT AND MURANO'S GLASS
ELEMENTS, DECORATIVE AND AMAZING ARE
PERFECT FOR ANY INTERIOR.

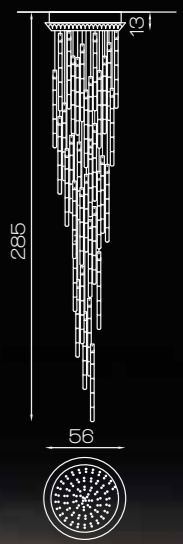

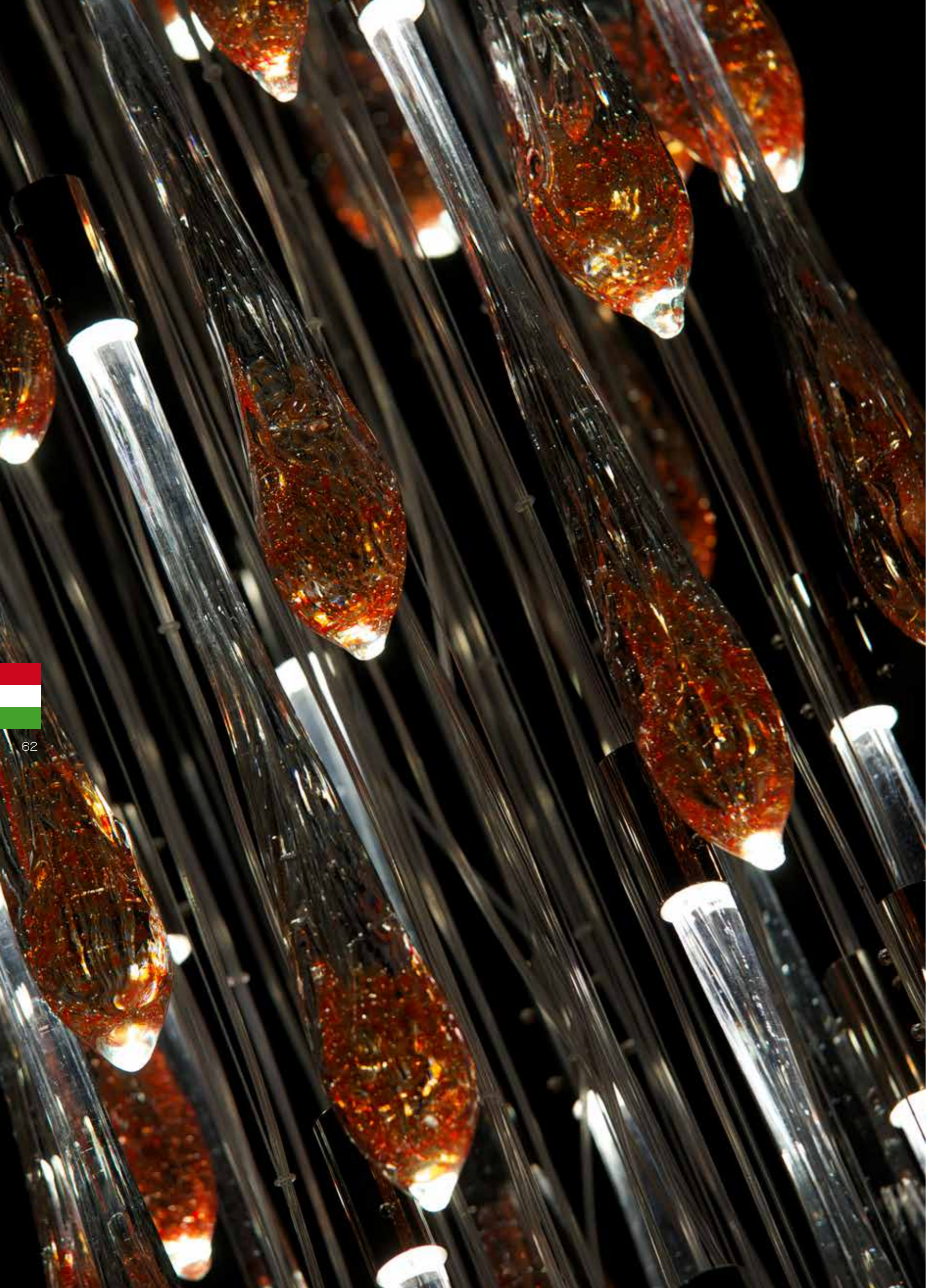

Art.1934
MURANO RED DROPS
H 275 cm ø 56 cm
15 x E14 X 40W

Art.1934 LED
MURANO RED DROPS
H 275 cm ø 56 cm
57 Led 450W

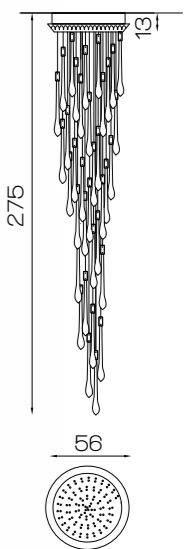
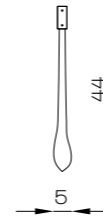

Art.1974
MURANO GLASS LEAF
H 285 cm ø 80 cm
15 x E14 x 40W

Art.1974 LED
MURANO GLASS LEAF
H 285 cm ø 80 cm
57 LED 450W

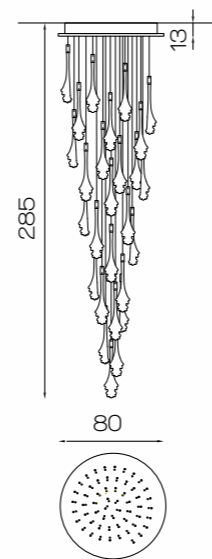
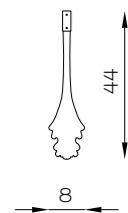

64



65



Art.1957 Led
MURANO GLASS
FLOWERS and BAMBU'
H 285 cm ø 90 cm
57 Led 450W

Art.1957
MURANO GLASS
FLOWERS and BAMBU'
H 285 cm ø 90 cm
15 x E14 x 40W

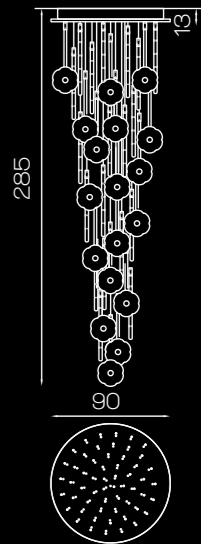
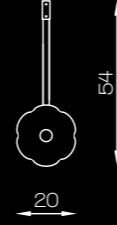

285





Art.1958 LED GLASS
CILINDER FLOWERS
H 285 cm ø 80 cm
57 LED 450W

Art.1958 GLASS CILINDER
FLOWERS
H 285 cm ø 80 cm
15 x E14 x 40W

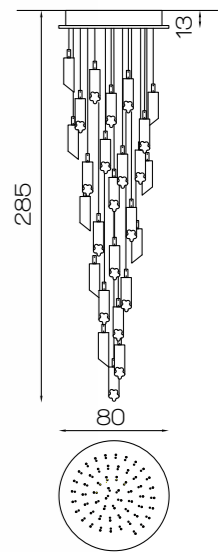
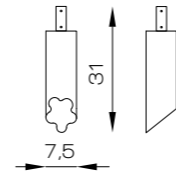

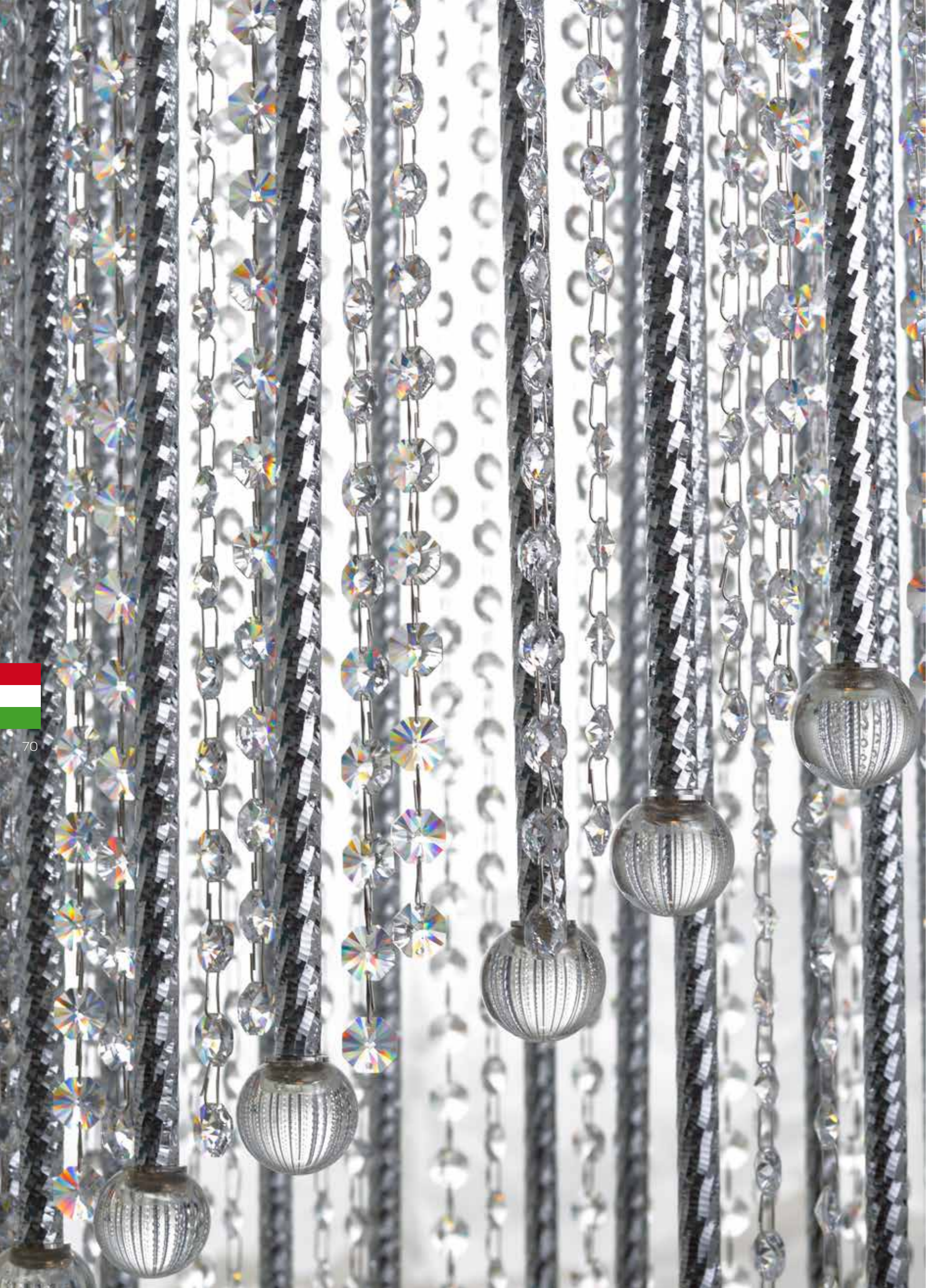

70



71

Art.1928
DIAMOND TUBE BRASS AND
SWAROVSKI SPECTRA CRISTAL
H 440 cm ø 110 cm
20 x E14 x40W



72



73

Art.1936
H 75 cm ø 150 cm
+ Ceiling plate H 10 cm ø 21 cm
14 x E27 x 60W

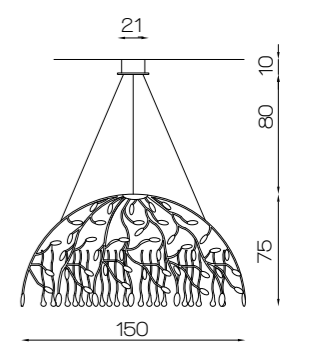

Il Paralume Marina

Art.1967/CH22/LU
H 94 cm ø 122 cm
22 x E14 x 40W



Art.1967/CH58/LU
H 208 cm ø 148 cm
58 x E14 x 40W



Chandelier made with polished gold fusion brass and castles of transparent and sable Murano's Glass. Symbol of handcraft excellence and refinement of materials, design and classic creating a bright masterpiece effect

Art.1956/CH18/LU
H 94 cm ø 142 cm
18 x E14 x 40W



76



77

*Creations of melted brass polished gold.
A very refined and valued classic that
never grows old*

Art.1956/A2/LU
H 59 cm L 38 cm Sp 21 cm
2 x E14 x 40W



Art.1956/CH6/LU
H 64 cm ø 92 cm
6 x E14 x 40W



Art.1953/LU/AM
H 120 cm Pø 40 cm
1 x E27 x 60W
Nappa N.44 Oro



Art.1953/NL/TR
H 120 cm Pø 40 cm
1 x E27 x 60W
Nappa N.45 Argento



Art.1953/NL/RS
H 120 cm Pø 40 cm
1 x E27 x 60W
Nappa N.49



Art.1953/NL/AZ
H 120 cm Pø 40 cm
1 x E27 x 60W
Nappa N.44 Argento

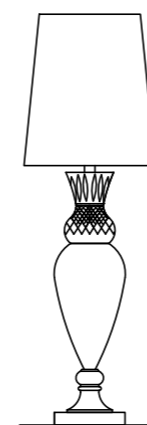

Art.1953/P
H 82 cm Pø 26 cm
1 x E27 x 40W



Art.1953/LU/AM
H 120 cm Pø 40 cm
1 x E27 x 60W
Nappa N.44 Oro



Art.1953/LU/M
H 120 cm Pø 40 cm
1 x E27 x 60W
Nappa N.46



Art. 1914/CH6/AV
H 41 cm ø 83 cm
6 x E14 x 40W

*Collection of lighting objects in cast brass
and Florentine crystal cut by hand*



Art. 1904
H 87 cm Pø 40 cm
1 x E27 x 60W

Art. 1914/CH12/AV
H 61 cm ø 103 cm
12 x E14 x 40W



84



85

Art. 1914/A2/AV
H 38 cm ø 41 cm
2 x E14 x 40W

Art.1975/CH18/LU
H 128 cm ø 144 cm
18 x E14 x 40W



Art.1983/FL/LU/RO
H 180 cm ø 80 cm Pø 20 cm
5 x E14 x 40W



Art.1983/CH6/LU/RO
H 90 cm ø 81 cm
6 x E14 x 40w



Art.1983/CH8/LU/RO
H 90 cm ø 81 cm
8 x E14 x 40w

Art.1983/CH18/LU/RO
H 126 cm ø 152 cm
18 x E14 x 40W



Art.1983/A2/LU/RO
H 33 cm L 60 cm
Pø 20 cm Sp 35 cm
2 x E14 x 40W



90

Art.1986/CH6
H 61 cm ø 66 cm Pø 16 cm
6 x E14 x 40W



91

Art.1985/CH6
H 61 cm ø 60 cm
6 x E14 x 40W





Art.1941/A2/TR
H 56 cm L 40 cm
Sp 21 cm Pø 16 cm
2 x E14 x 40W

Art.1941/CH6/OV/TR
H 52 cm ø 86 cm Pø 16 cm
6 x E14 x 40W



Art.1941/CH12/BR/TR
H 87 cm ø 130 cm Pø 18 cm
12 x E14 x 40W

Art.1850/CH36/ORO24K/NR
H 120 cm ø 176 cm Pø 16 cm
36 x E14 x 40W

PARALUME IN SETA
AVORIO SU FODERA DORATA



Art. 1850/CH12/ORO24K/NR
 H 73 cm ø 107 cm Pø 16 cm
 12 x E14 x 40W

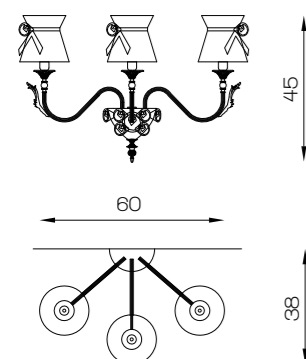

Art.1850/A3
 H 45 cm L 60 cm Sp 38 cm
 3 x E14 x 40W

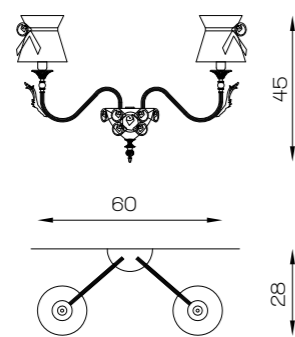

Art.1850/A2
 H 45 cm L 60 cm Sp 28 cm
 2 x E14 x 40W

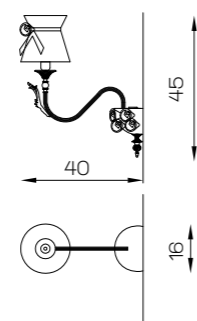

Art.1850/A1
 H 45 cm Pø 16 cm Sp 40 cm
 1 x E14 x 40W



Art.1850/P/ORO24K/FUMÉ
 H 82 cm Pø 32 cm
 1 x E27 x 60W



Art.1850/G/ORO24K/FUMÉ
 H 105 cm Pø 43 cm
 1 x E27 x 60W

Art.1968/CH16/LU
H 133 cm ø 115 cm
16 x E14 x 40W



Art.1982
H 150 cm ø 50 cm
7 x E14 x 60W

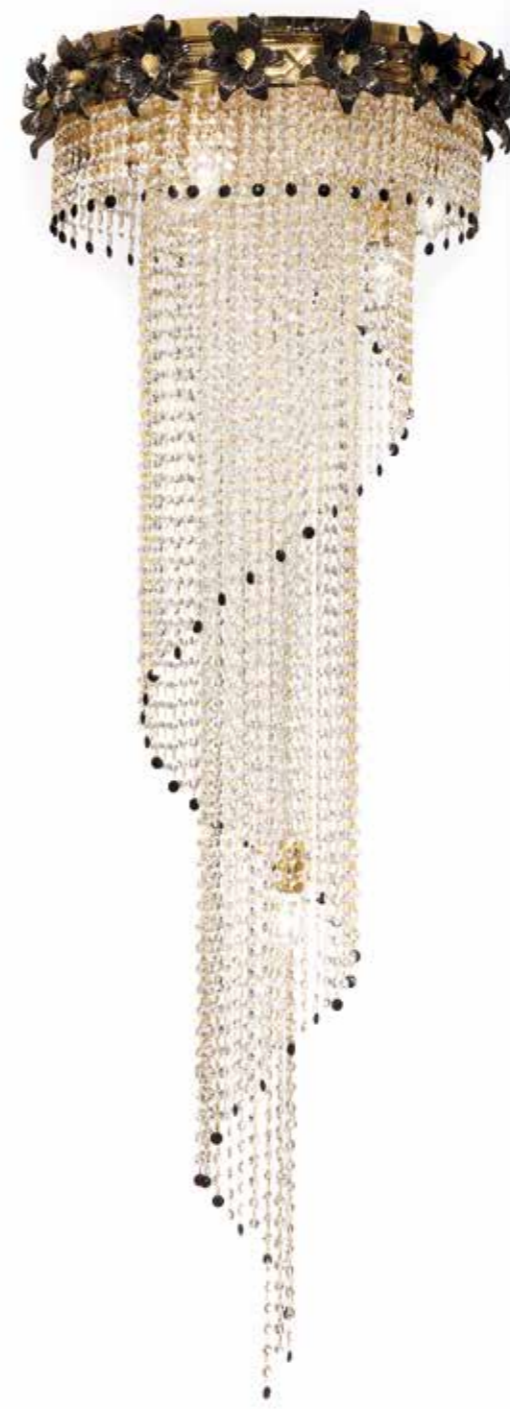

Art.1981
H 150 cm ø 50 cm
7 x E14 x 60W





Art.1887
H 207 cm ø 100 cm
14 x E14 x 40W
6 x E27 x 60W



Art.1902/P
H 63 cm Pø 35 cm
1 x E27 x 60W

Art.1902/G
H 85 cm Pø 45 cm
1 x E27 x 60W





Art.1949/A2/LU
H 52 cm L 40 cm
Sp 21 cm Pø 14 cm
2 x E14 x 40W



Art.1949/FL/LU
H 192 cm ø 64 cm
Pø 14 cm
8 x E14 x 40W



Art.1949/CH16/LU
H 111 cm ø 111 cm
Pø 14 cm
16 x E14 x 40W



Art.1949/FLAMBÒ/LU
H 83 cm ø 42 cm
Pø 14 cm
4 x E14 x 40W



Art.1955/A2/LU
H 60 cm L 52 cm Sp 34 cm
2 x E14 x 40W



Art.1955/G/LU
H 95 cm Pø 46 cm
1 x E27 x 60W

Art.1955/P/LU
H 70 cm Pø 34 cm
1 x E27 x 40W

*Chandelier made with transparent
gold Murano glass with flames,
boubeches on transparent
hand-cutted italian cristal*



Art.1955/CH12/LU
H 80 cm ø 120 cm
12 x E14 x 40W





Art.1955/FL/LU
H 188 cm Pø 48 cm
2 x E27 x 60W



Art.1955/CH6/LU/GR
H 85 cm ø 80 cm
6 x E14 x 40W



Art.1792/CH9
H 73 cm ø 82 cm
9 x E14 x 40W



Art.1793/CH9
H 73 cm ø 93 cm
Pø 16 cm
9 x E14 x 40W



Clear Murano glass chandelier by sinuous and balanced lines with elements in chrome or gold crowned with the lampshades sewn in pure white silk on the white lining, trimming in sparkling crystals by Swarovski Elements



Art.1793/FL
H 185 cm ø 76 cm
Pø 16 cm
6 x E14 x 40W



Art.1793/A
H 47 cm Pø 16 cm
2 x E14 x 40W



Art.1793/G
H 85 cm Pø 45 cm
1 x E27 x 60W



Art.1964/CH18/NL
H 136 cm ø 85 cm
18 x E14 x 40W



Art.1963/NL
H 70 cm ø 100 cm
14 x E14 x 60W

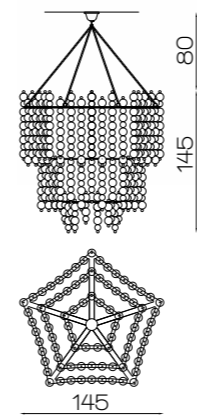

Art.1980/LU/TR
H 145 cm ø 145 cm
+ 80 cm chain
30 x E14 x 40W



Art.1917
H 76 cm L 40 cm
2 x E27 x 60W



Art.1891
H 80 cm Pø 45 cm
1 x E27 x 60W



italy
karina



114



115



Art.1951/LU/TR
H 98 cm Pø 38 cm
1 x E27 x 60W



Art.1951/LU/RO
H 98 cm Pø 38 cm
1 x E27 x 60W
Nappa N.47



Art.1942
H 88 cm ø 41 cm
1 x E27 x 60W



Art.1897/G
H 88 cm Pø 45 cm
1 x E27 x 60W
Nappa N.48



Art.1771/G
H 20 cm ø 50 cm
3 x E27 x 60W

Art.1772/G
H 20 cm ø 50 cm
3 x E27 x 60W



Art.1494/A
H 20 cm ø 50 cm
3 x E14 x 60W

Art.1494/B
H 20 cm ø 50 cm
3 x E14 x 60W



Art.1773/PLU
H 17 cm ø 24 cm
1 x E27 x 40W

Art.1773/G/LU
H 24 cm ø 38 cm
3 x E27 x 60W



Art.1905
 H 130 cm ø 55 cm
 3 x E14 x 40W



Art.1923/NL



Art.1922/BR



Art.1922/NL



Art.1922/LU



Art.1906
 H 190 ø 40
 Ball ø 20 cm
 5 x E27 x 60W

Picture wall lamp
 ø 31 cm Sp 25 cm ø Base 10 cm
 5 Led Luce bianco caldo 3150°K
 86 Lm/W Consumo 1 W per led



 **IL PARALUME MARINA**
Italy

di Ferronato Emma Marina s.n.c.
Vicolo Col Beretta, 6
36022 San Zeno di Cassola (VI) ITALY

Tel. +39 0424 33 042
Fax +39 0424 511 817

www.ilparalumemarina.it
info@ilparalumemarina.it
Skype: ilparalumemarina

Tutte le misure
sono indicate in cm.
H = altezza
Sp = sporgenza
Ø = diametro
PØ = diametro del paralume.

Design: Arch. Federica Vicentini
Project Director: Thomas Simoncello

Printing: Girardi Print Factory

Tutti i diritti riservati.
Sono vietate la pubblicazione la trasmissione la fotocopiatura
e qualsiasi altra forma di duplicazione o riproduzione, parziali
e totali dei testi e della grafica qui contenuti, senza il preventivo
consenso scritto della ditta il Paralume Marina.
Il produttore si riserva il diritto di introdurre modifiche tecnicoche.
Il produttore declina qualsiasi responsabilita per eventuali errori di stampa.

Il Paralume Marina

MADE WITH
SWAROVSKI
ELEMENTS

SWAROVSKI® è un marchio registrato



Il Paralume Marina
Made in Italy

www.ilparalumemarina.it